

CertainTeed  
**EverNew**<sup>®</sup>  
Vinyl Railing and Deck Systems

Full Line



**CertainTeed** 

*Quality made certain. Satisfaction guaranteed.<sup>™</sup>*

Enduring Strength

Rugged

# CertainTeed

CertainTeed

Colors That Last



Durable

Easy to Clean

Safe, Slip Resistant Surfaces

Easy to Install

Code Approved

Timeless Beauty

EverNew®

Limited Lifetime Warranty

# EverNew®

## Table of Contents

**Why CertainTeed Vinyl? . . . . .1**

**Metal-to-Metal . . . . .2-3**

**Oxford and Cambridge:**

A routed post, steel post support kit system provides the ultimate in beauty, quality and durability.

**Metal-to-Wood . . . . .4-5**

**Oxford and Cambridge:**

A sleeve-over-lumber system with an aluminum bracket and vinyl cover offers premium quality without the premium price.

**Metal-to-Wood . . . . .6-7**

**Kingston:**

This sleeve-over-lumber system with aluminum bracket and vinyl cover is the smart choice for value conscious consumers.

**Decking System . . . . .8-9**

Easy care decking system - perfect for decks, docks, pools and hot tubs.

**Hand Rail System . . . . .10-11**

The vinyl hand rail system that meets ADA code requirements.

**Structural Posts & Accessories . .12-13**

Finish off every project with EverNew posts, caps, trim and decorative accessories.

**Product Specifications . . . . .13**

# Why CertainTeed Vinyl?

## Discover the Advantages of EverNew® Railing and Decking



### EverNew Vinyl Facts

- Consistent quality and appearance
- Easy to install and clean
- Complete deck, dock, balcony and porch systems
- Concealed fasteners
- Virtually maintenance-free; no painting or staining
- Meets ADA recommendations for slip resistance
- Class 1 (A) fire rating
- Listed with the ICC-ES
- Lifetime warranty with 5 year SureStart™ protection

### Vinyl Products vs. Wood

Compared to wood, vinyl:

- Does not rot or decay
- Won't split, crack, twist, warp or splinter
- Resists UV rays and salt spray
- Is impervious to wood-boring insects
- Is virtually maintenance-free
- Stays beautiful year after year
- Non-porous surfaces resist spills and stains
- Superior color retention

### Why CertainTeed?

- Leader in building products since 1904
- #1 in brand use and awareness
- Industry's widest selection of building products
- Outstanding product performance at every price option
- Online resources
  - [www.certainteed.com](http://www.certainteed.com)
  - Fax-on-Demand
  - Contractor Locator
  - Education Programs
- Building Solutions® Product Portfolio
- Sales Support Group 800-233-8990



# Metal-to-Metal System

## Routed Post, Steel Post Support Kit Installations

...providing the ultimate rail to post connection with a hidden hardware system.



### Rail Plate

- Made of stainless steel
- Screw flange secures top rails inside post
- Oval cut out works for all flat and stair applications

### Rugged Aluminum Reinforced Top and Bottom Rail

6', 8' and 10' Lengths Standard in Flat, Stair or Steep Stair (Steep Stair 6' and 8' only)

### E-Z Set Brackets

- Made of aluminum
- Keeps post square and snug



### Sturdy Post Support Pipe

- Hot galvanized steel
- 1-5/8" outside diameter

### Baluster Styles

- Colonial
- Square

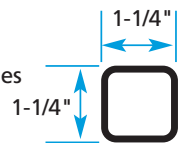

4" Tempered Glass Baluster Infill\*, in Clear or Smoked (Available in 3-1/2' Oxford Systems Only)

Weather-Resistant Vinyl Exterior Available in 3' and 3-1/2' Heights

Attractive Precision-Fit Components

4" x 4" and 5" x 5" Post Trims Available

### Secure Mounting Systems

- Fasteners provided for both wood and concrete applications (wood deck mounting shown here)

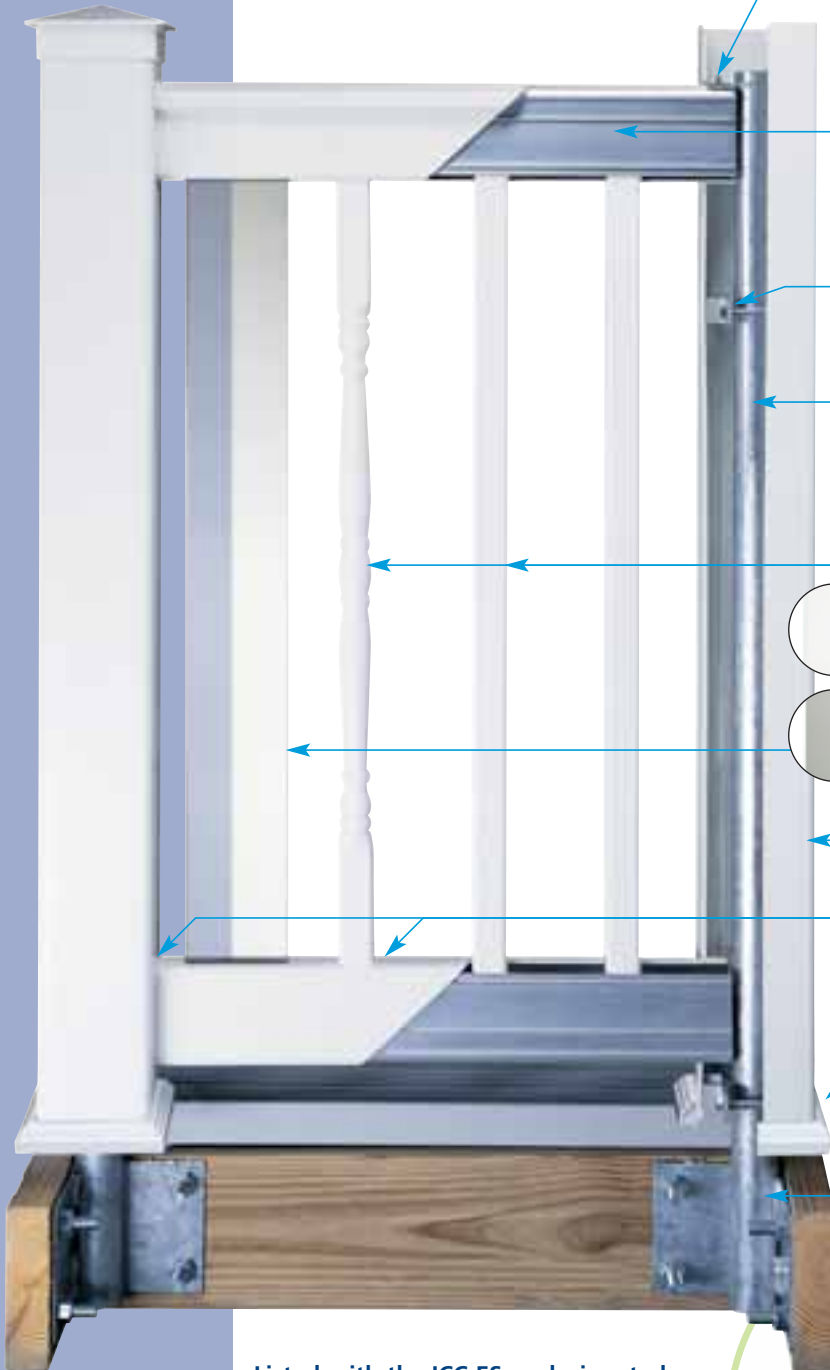
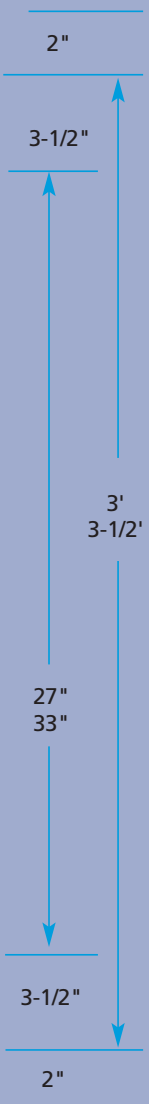

Listed with the ICC-ES as designated by the report **NER-605**

Suitable for residential and commercial applications – including multifamily and over three story installations.

Refer to page 13 for post and cap options.

\* Designed to meet IBC but not included in report NER-605

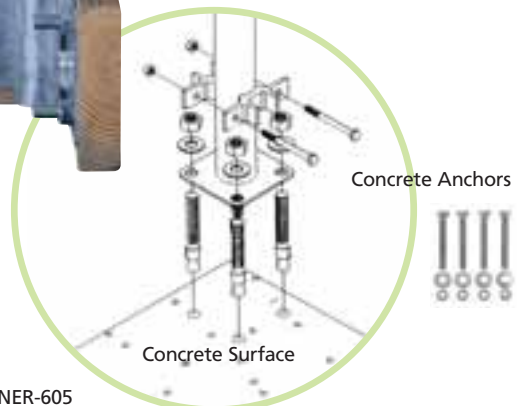

Only the best will do when it comes to safety. The Metal-to-Metal connection is our strongest system and has been approved for the highest building codes. The routed posts allow for a clean, invisible connection and great aesthetics.

## Top Rail

Oxford

Cambridge

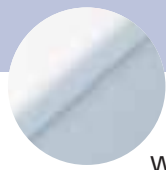

White



Tan

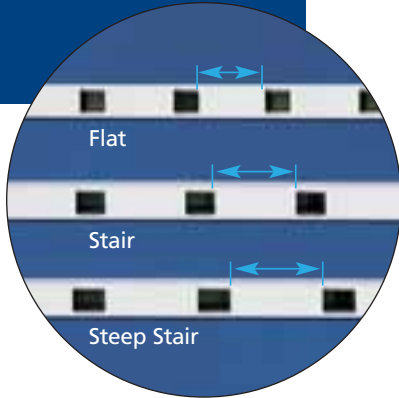
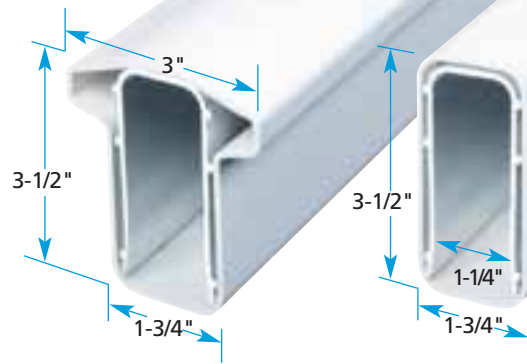

### Baluster Hole Spacing

Top and bottom rails are routed to accept 1-1/4" x 1-1/4" balusters. Stair baluster spacing is wider to account for racking.

### Stair/Step Section

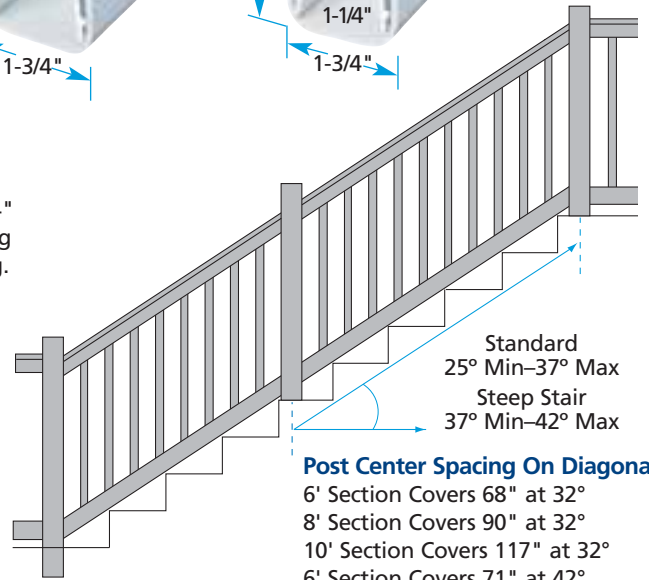

## Routed Post Options

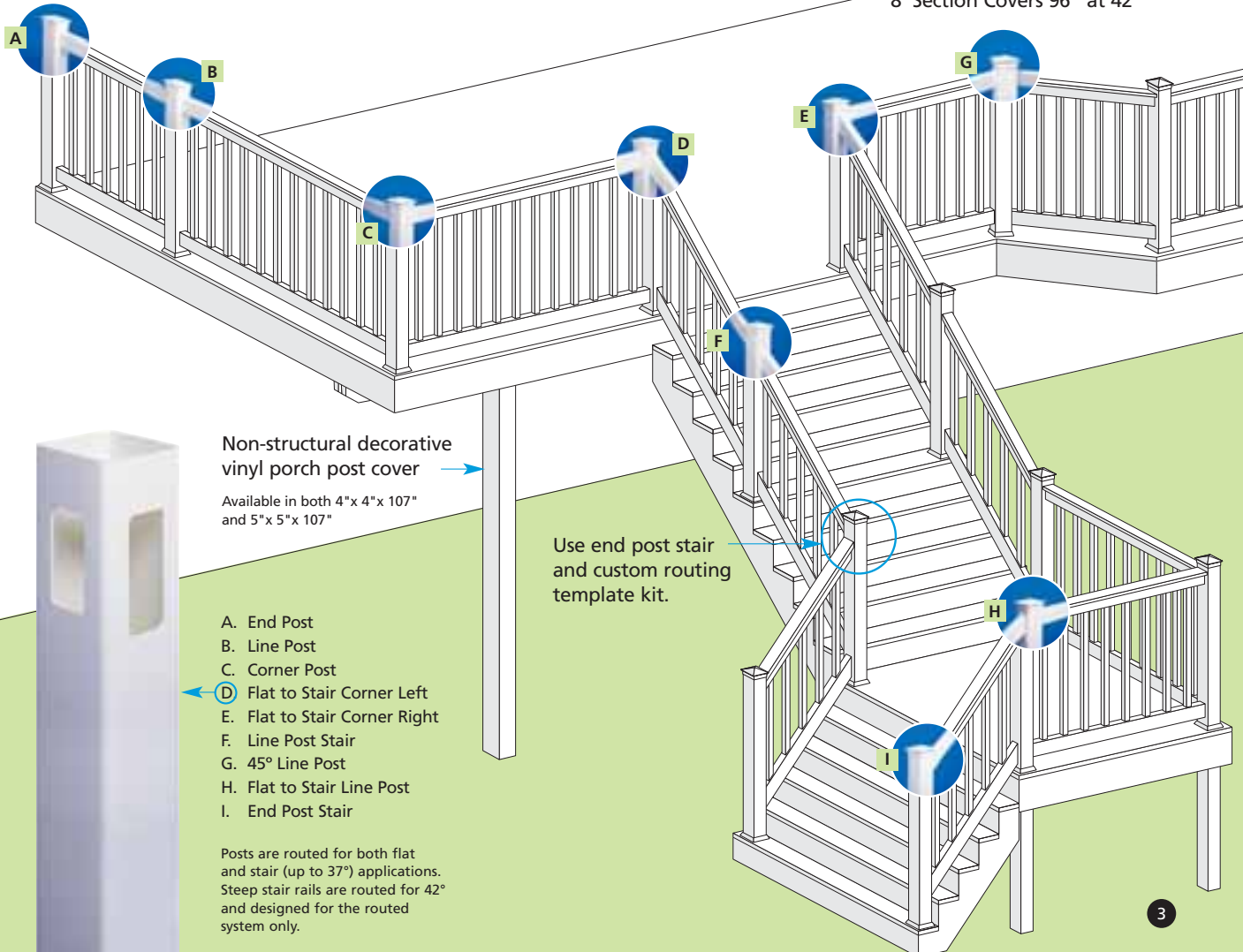

# Metal-to-Wood System

## Aluminum Bracket, Sleeve Over Installations

...for use with existing wood posts, porch posts or columns.

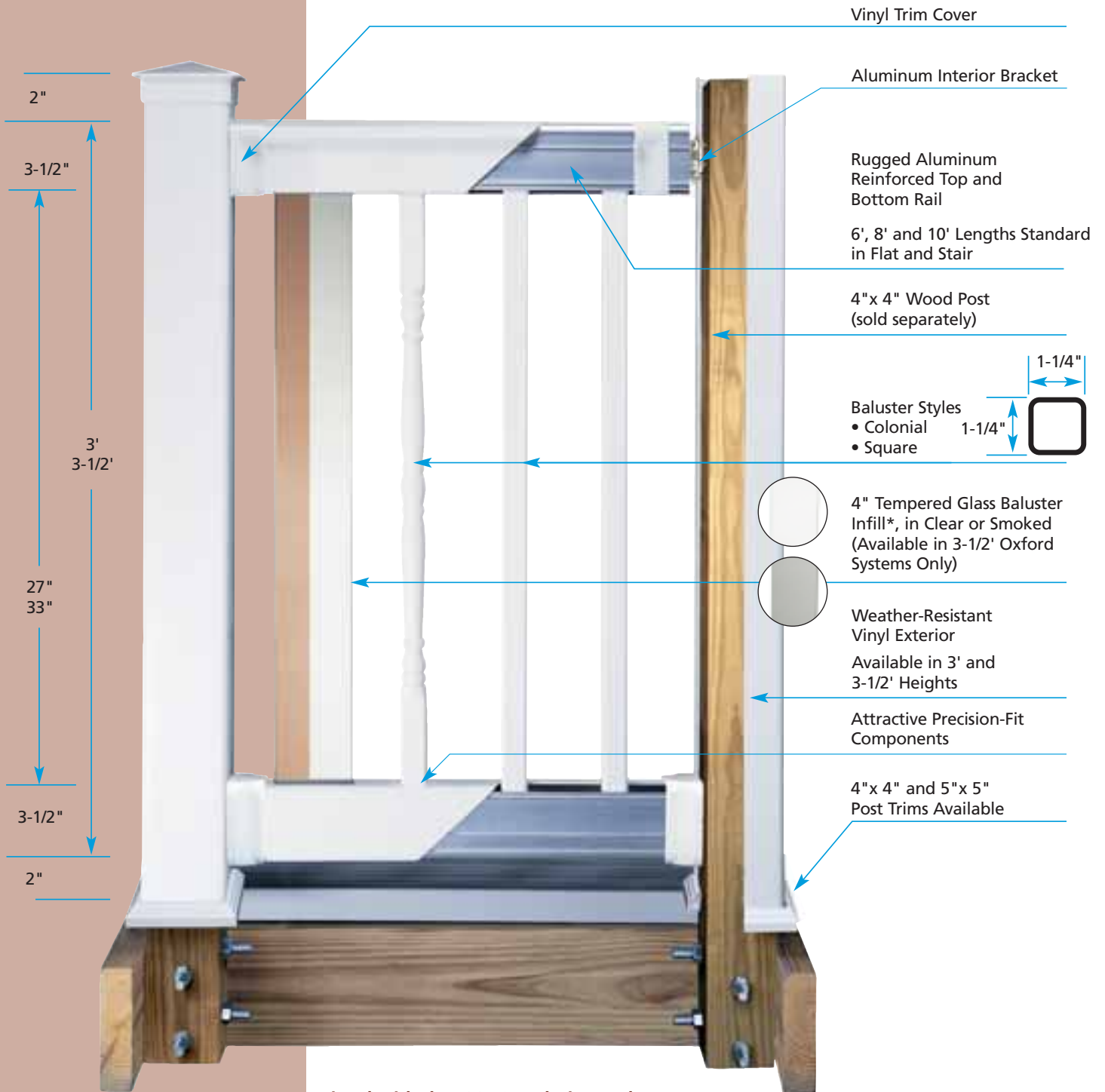

Listed with the ICC-ES as designated by the report **NER-605**

Suitable for residential and commercial applications – including multifamily and over three story installations.

Refer to page 13 for post and cap options.

\* Designed to meet IBC but not included in report NER-605

The easy to install Oxford and Cambridge rail mount brackets provide a secure metal rail-to-post connection. They are versatile for flat, stair, column and 45° installations and are appealing with or without vinyl trim covers.

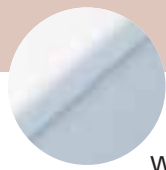

White



Tan

## Top Rail

Oxford

Cambridge

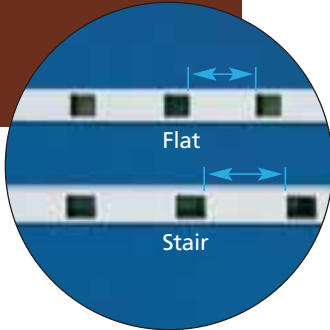
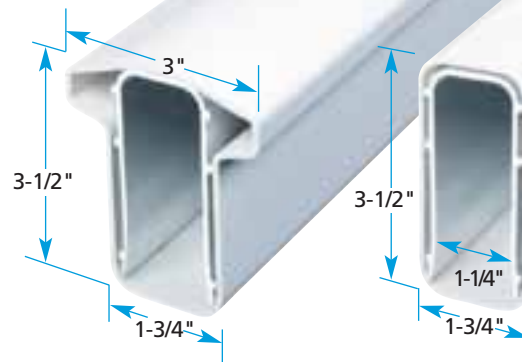

Flat

Stair

### Baluster Hole Spacing

Top and bottom rails are routed to accept 1-1/4" x 1-1/4" balusters. Stair baluster spacing is wider to account for racking.

### Stair/Step Section

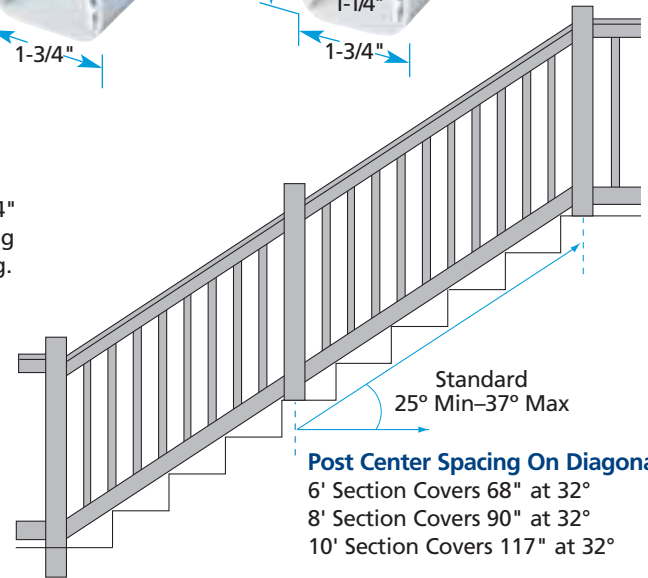

### Post Center Spacing On Diagonal

6' Section Covers 68" at 32°  
8' Section Covers 90" at 32°  
10' Section Covers 117" at 32°

## Trim Covers

Decorative slide over trim covers conceal screws and streamline the appearance.



Oxford Flat



Cambridge Flat



Oxford Column  
(minimum 8" round column)



Cambridge Column  
(minimum 8" round column)



Oxford 45°



Cambridge 45°



Oxford Stair



Cambridge Stair

Field Cut

## Brackets



Aluminum bracket screws to post or wall providing a solid, durable connection

Stainless Steel Screws secure rail to bracket

### Rail Mount Bracket System

- Aluminum interior brackets
  - The critical rail to post stress point is secured by corrosion resistant aluminum
  - Mounts to any post or wall
- Vinyl trim cover
  - Sleek design to conceal screws
  - Easily altered for close baluster applications

### Alternate Rail Mount Bracket

(Concealed bracket for use without covers)



Standard mounting bracket works for both flat and stair applications in either Oxford and Cambridge Railing Systems. Made of corrosion resistant aluminum.

# Metal-to-Wood System

## Aluminum Bracket, Sleeve Over Installations

...for use with existing wood posts, columns, gazebos, or porch posts.

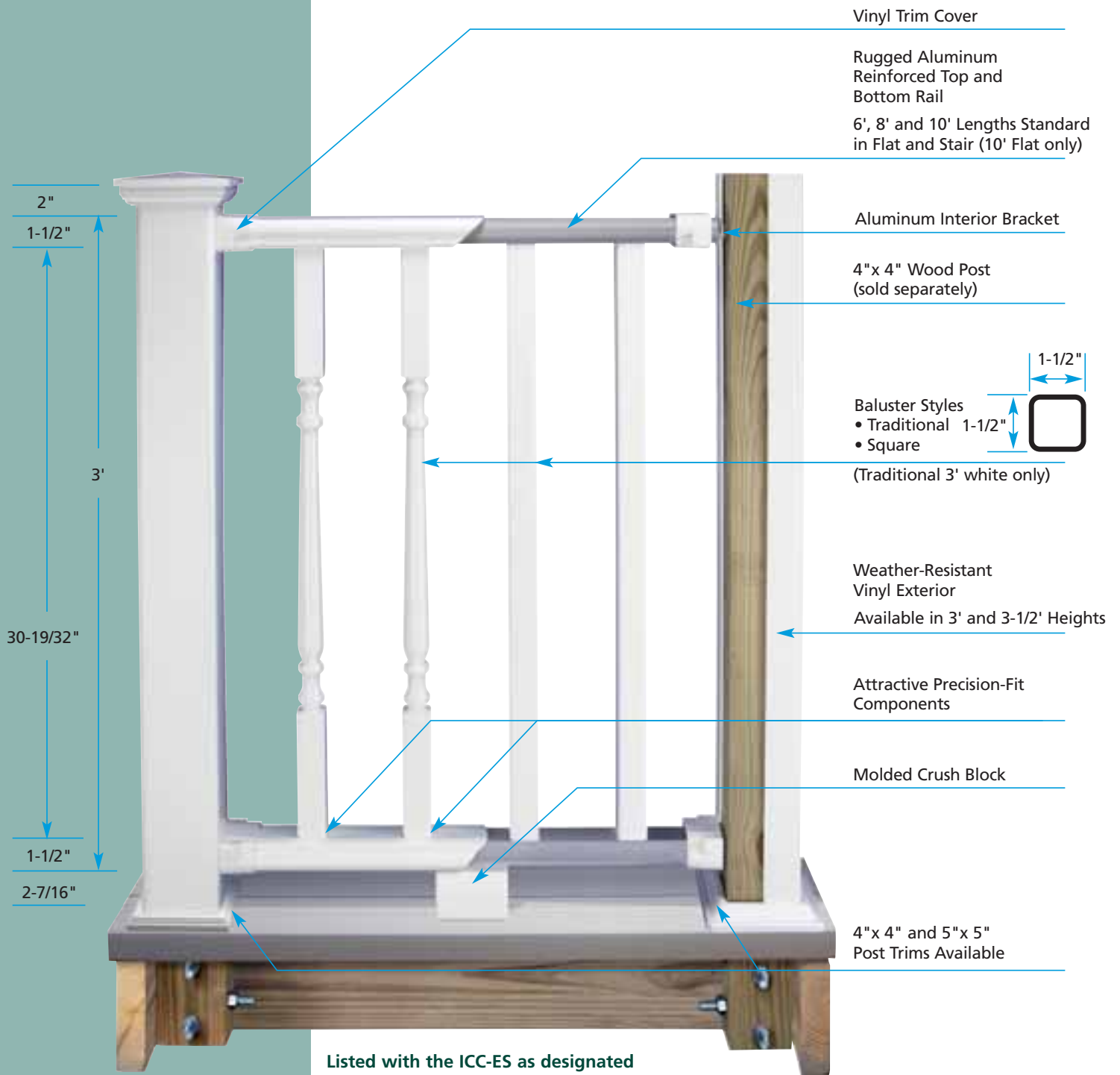

Listed with the ICC-ES as designated by the report ESR-1555

Suitable for one- and two-family dwellings and townhouses not more than three stories in height.

Refer to page 13 for post and cap options.



The traditional wood styling of Kingston railing makes it perfect for deck and porch applications. Kingston's durable aluminum rail mount brackets are superior to plastic brackets – providing easy and secure installation in flat, stair, 45°, 22-1/2° and column installations.

## Kingston Top and Bottom Rails



White

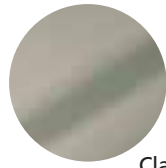

Clay

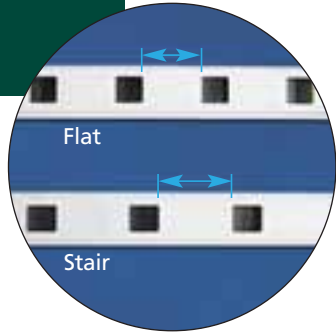
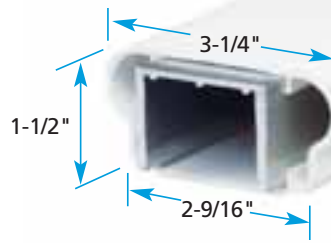

### Baluster Hole Spacing

Top and bottom rails are routed to accept 1-1/2" x 1-1/2" balusters. Stair baluster spacing is wider to account for racking.

### Stair/Step Section

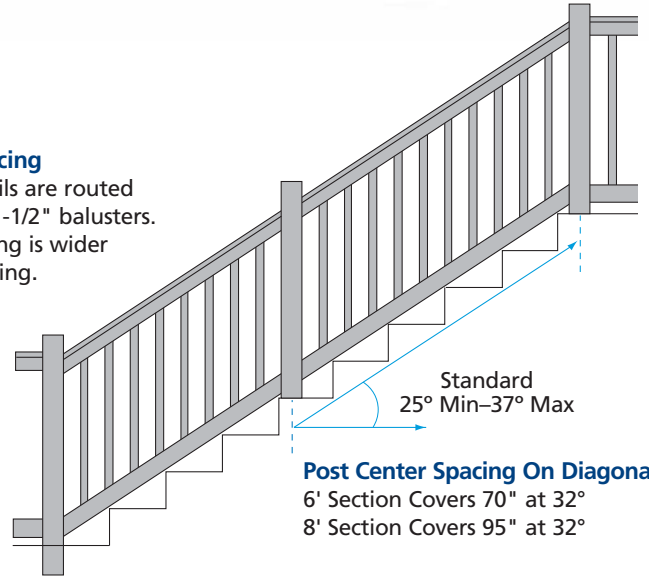

Standard  
25° Min–37° Max

### Post Center Spacing On Diagonal

6' Section Covers 70" at 32°  
8' Section Covers 95" at 32°

## Trim Covers

Sleek molded covers conceal screws and streamline appearance.



Flat



22-1/2° Left  
22-1/2° Right



45°



Column  
(minimum  
8" round  
column)



Field Cut

Stair

## Brackets



Aluminum  
bracket screws to  
post or wall  
providing a solid,  
durable connection

Screws secure  
rail to bracket

### Aluminum Interior Brackets

(more than just a plastic bracket)

- The critical rail to post stress point is secured by corrosion resistant aluminum
- Mounts to any post or wall
- Uniquely designed for specific applications

### Vinyl Trim Cover

- Sleek design to conceal screws
- Easily altered for close baluster applications



# Decking System

**Easy To Install, Easy To Maintain**

...Easy to clean surface is perfect for busy,  
no maintenance lifestyles.



# Decking System

Enjoy carefree outdoor living. EverNew decking features an easy to clean non-porous vinyl surface that won't stain from accidental spills or ground-in dirt. Deck systems are offered in a variety of colors that are UV protected for long-term durability and superior color retention.

And EverNew decking isn't just for decks. Install the vinyl deck planks around a pool, hot tub, or even build a dock or boat slip.

## Styles and Colors

### Three Popular Colors

### Four Plank Lengths

1-1/2" x 5-1/2" Plank  
12', 16', 20', 24' Lengths

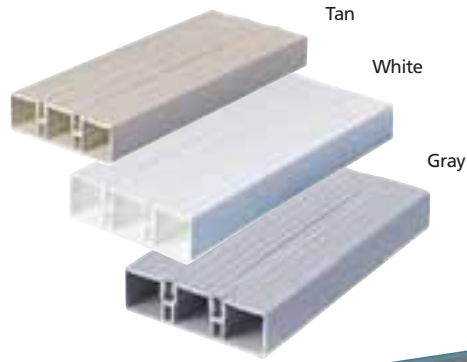

### Snap-In Fill Pieces Hide Fasteners

12', 16', 20', and 24' lengths

### Easy-To-Install Planks Screw Directly to Joists and Prevent Squeaking

### Safe, Non-Slip, Raised Ridge Tread

End Cover Fastener



End Cover 12' lengths

1-1/2"  
1-5/8"

Cuts, Fastens and Handles Easier than Wood Planks

Rigid Multi-Ribbed Profile  
Spans 24" joist spacing  
(16" recommended)

### Attractive Fascia Boards for Finishing Stairs and Framing

7/8" x 6" x 96"  
7/8" x 3" x 96"  
7/8" x 1-1/2" x 96"



3/4" Fascia Cover Plug



# Hand Rail System

## Vinyl Hand Rail Component Systems

...Meet local code with the EverNew

1-1/2" vinyl hand rail components.



- Complies with ADA (Americans with Disabilities Act) requirements for grippable hand rails
- 1-1/2" diameter gripping area
- Continuous hand rail runs
- Safe for stair and ramp applications
- Aluminum reinforced construction reduces bowing and provides enduring strength
- Functional finishing touches: post and wall returns, end caps and loops
- Unique adjustable internal joiner accommodates any transition – 0° to 90° bends
- Installs easily on site with no preformed fittings
- Ideal for use with EverNew railing system
- Virtually maintenance free
- Lifetime limited warranty
- EZ Set bracket kit available for attachment to routed system

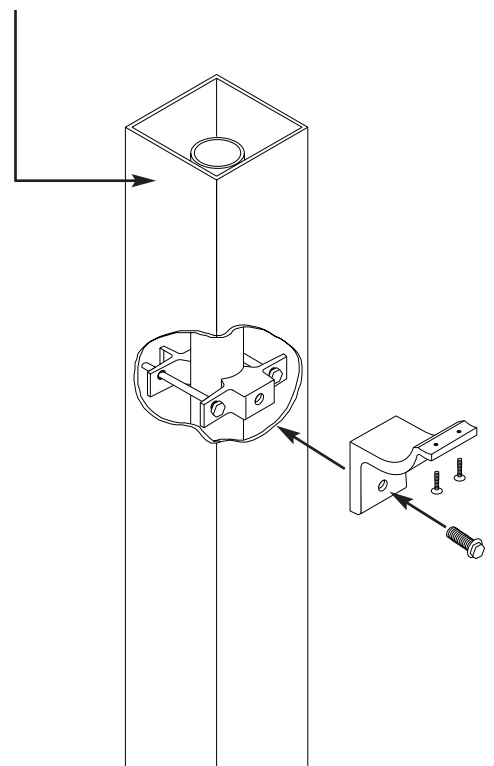

# Vinyl Hand Rail

## # Description

1. 1-1/2" DIAMETER VINYL END CAP
2. FLANGE COVER 3-1/2"x3-1/2"
3. 2-1/2" MINI WALL MOUNT FLANGE - ALUMINUM
4. ADJUSTABLE INTERNAL JOINER
5. 1-1/2" OD ADA END LOOP 18"x12"x18"
6. 1-1/2" OD - 90° CORNER - 12"x12"
7. 1-1/2" OD - 90° CORNER/END POST - 12"x36"
8. 1-1/2" OD - 90° WALL RETURN - 12"x2-3/4"
9. 1-1/2" OD - 180° POST RETURN - 16.5"x6"
10. 1-1/2" OD X 6' VINYL HAND RAIL W/ALUMINUM INSERT
11. 1-1/2" OD X 8' VINYL HAND RAIL W/ALUMINUM INSERT
12. 1-1/2" OD X 10' VINYL HAND RAIL W/ALUMINUM INSERT
13. 30" FLANGE POST INTERIOR - GALVANIZED
14. 34" CORE POST INTERIOR - GALVANIZED
15. HAND RAIL BRACKET ASSEMBLY
16. HAND RAIL EZ POST ATTACH KIT

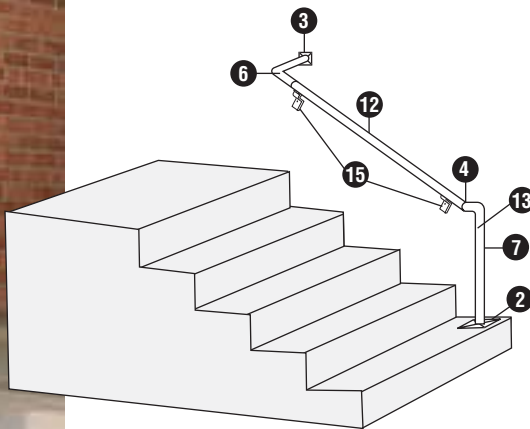
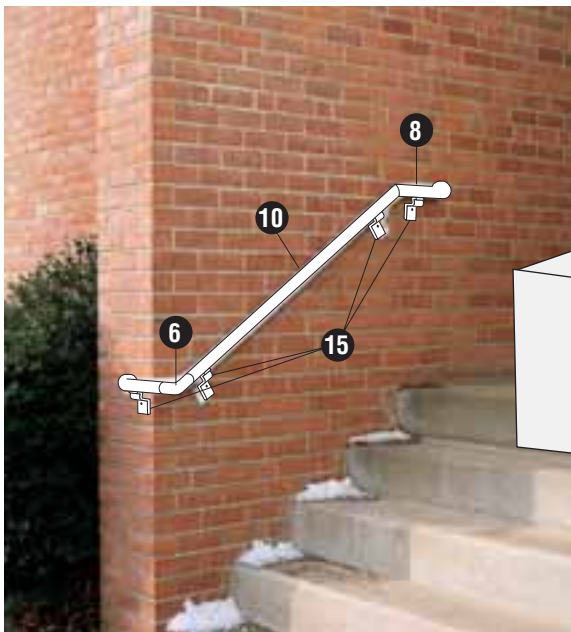
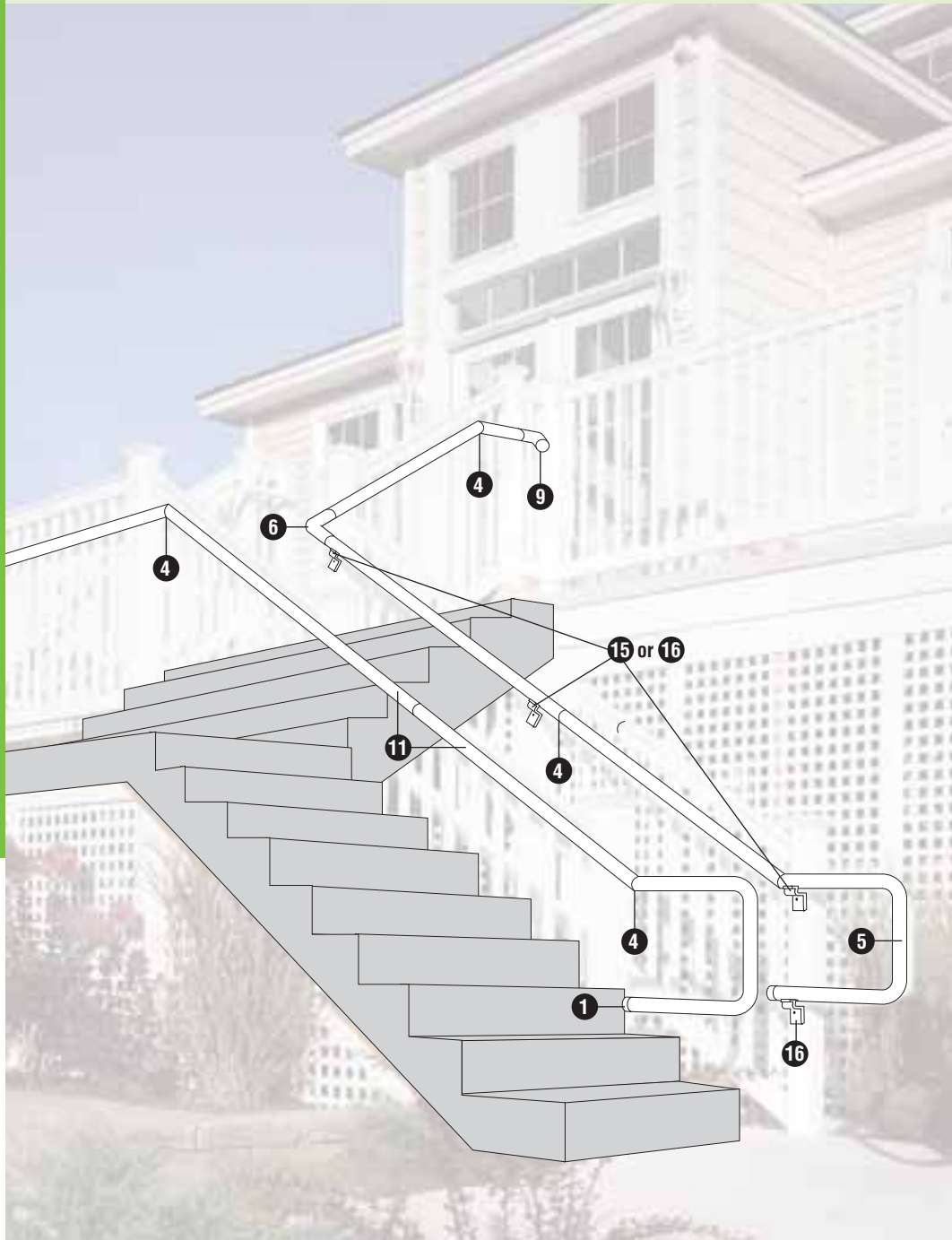

**Note:** Hand rail depicted is not free standing and must be anchored to walls or guardrail using hand rail bracket assembly (E74028/E74029). Space a maximum of 5' on center and as close as possible to both sides of any joint.

# Accessories

**Porch Posts and Post Wraps**...and a variety of finishing accessories to complement any project, regardless of which railing style or system is chosen.



## New SnapWrap™

SnapWrap™ vinyl post wrap from CertainTeed is the quick, convenient way to wrap wood porch posts in easy-care style. Designed to coordinate with CertainTeed's vinyl deck and railing products, SnapWrap delivers all of the low-maintenance benefits of vinyl posts without having to replace existing wood porch posts.

- Specially designed for existing wood posts
- Available in 4" x 4" x 10' as well as 6" x 6" x 10' lengths — can be field cut to any length
- 8-piece system — 4 vinyl post sections plus 4 corner trim pieces
- 4-piece post trim for top and bottom sold separately
- Components snap together for easy installation
- Tongue-n-groove connection
- Works well with all CertainTeed bracketed railing systems

### Structural Colonial

5" x 5"  
White & Tan

### Structural Colonial

4" x 4"  
White

### Structural Traditional

5" x 5"  
White

### Structural Square

5" x 5"  
White & Clay

### Non-Structural Decorative Porch Post Sleeves

Available in 4" x 4", White, Tan & Clay and 5" x 5" x 107", White & Tan

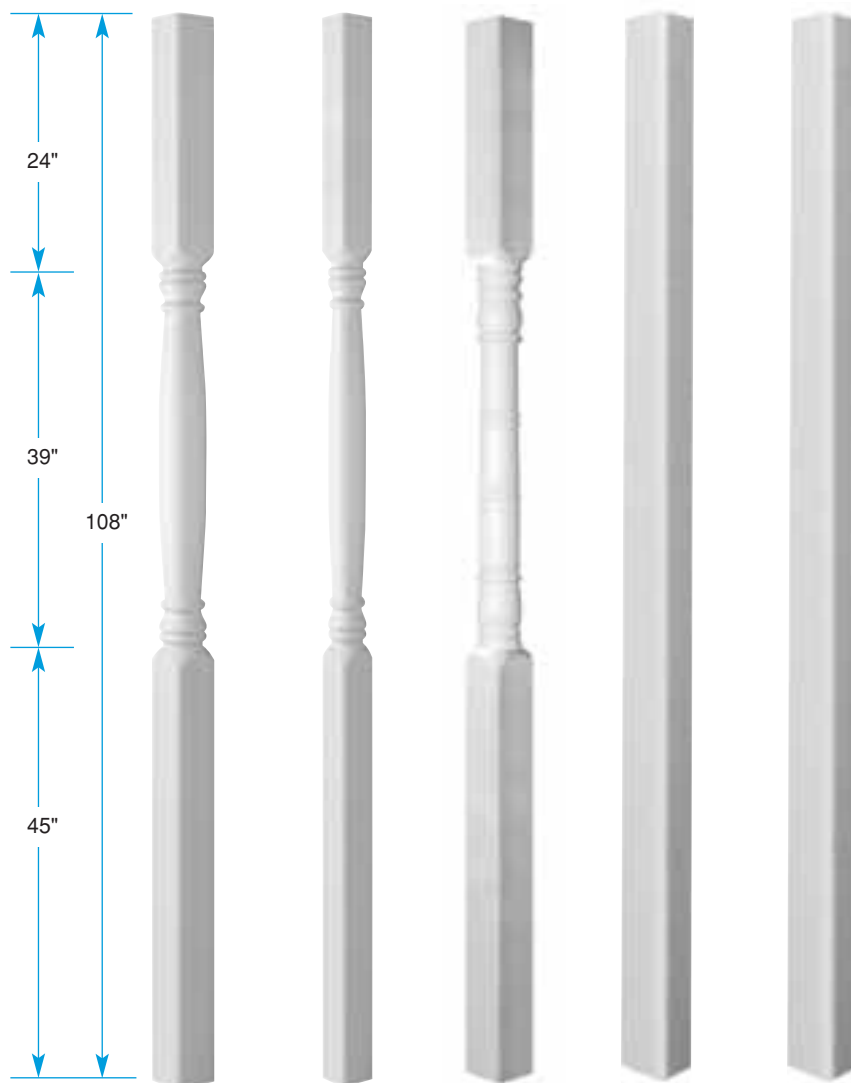

Structural porch posts are reinforced with a load-bearing support system. Each post comes with hurricane tie-down mounting plates and finishing trim pieces.

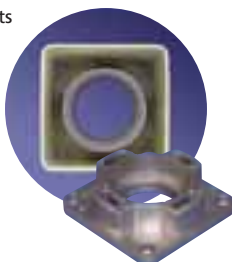

### Decorative Porch Bracket

- Measures 10-1/4" x 12-1/4"
- Low maintenance vinyl
- Works with any porch post
- Available in white

# Post Caps & Trim

## Square Post and Caps

These five Post Caps are available for EverNew square post styles.

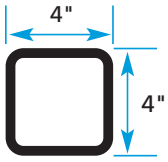

Flat Cap - Internal



Flat Cap - External



New England Cap



Ball Cap



Gothic Cap

Both Newel and Square have a 4" dimension.

Blank Posts available in 38", 44", 48" and 51-1/2".



## Newel Post and Caps

The newel post and caps create a more traditional look on your EverNew railing. Available for white 3' styles only.



King Cap



Queen Cap

Blank Newel Posts available in 38" and 44".

## Post Trim Options

Post Trim can be used for finishing posts. Available in White, Tan and Clay.

4 Piece Post Trims Available in 4"x 4" and 5"x 5".



1 and 2 Piece Post Trims Available in 4"x 4" and 5"x 5".



## Add a Deco Finish to your New England post cap

Aluminum cap with your choice of black or antique bronze finish. Available in 4"x 4" size.



## Safe. Strong. Durable.

EverNew deck and railing products meet stringent requirements for quality and safety. Our deck and railing systems are listed with ICC-ES and engineered to exacting standards for strength, durability and performance.

## Warranty

CertainTeed warrants its EverNew Vinyl Products with a lifetime limited warranty. Refer to Warranty Certificate for complete details and limitations.

## SureStart™ Protection

SureStart™ Protection covers warranted repair and replacement costs including labor for a period of five years after installation.

Both Newel and Square post styles are available blank for bracket installations as well as factory routed for metal-to-metal post support kit installations.

## Product Specifications

### Evernew Vinyl Railing

	Baluster Size	Picket Spacing	Section Width (Nominal)	Rails	Aluminum Reinforcement	Color
Oxford (T-Rail)	1-1/4" x 1-1/4"	3-3/8" Flat	72", 96" & 120"	3" x 3-1/2" x 71-1/2", 95-1/2" or 119-1/2" "T" Shaped Top Rail	Top & Bottom	White & Tan
Oxford (T-Rail) Glass Baluster Infill	4" x 3/8"	3-7/8" Flat	72"	3" x 3-1/2" x 71-1/2"	Top & Bottom	White Rail Clear & Smoked Glass
Cambridge (2x4)	1-1/4" x 1-1/4"	3-3/8" Flat	72", 96" & 120"	1-3/4" x 3-1/2" x 71-1/2", 95-1/2" or 119-1/2" Top & Bottom	Top & Bottom	White & Tan
Kingston (Top Round)	1-1/2" x 1-1/2"	3-7/16" Flat	72", 96" & 120"	3-1/4" x 1-1/2" x 68-1/2", 92-1/2" or 116-1/2" Top & Bottom	Top & Bottom	White & Clay

### Evernew Vinyl Decking

	Plank Size	Plank Spacing	Plank Length	Reinforcement	Color
Deck	1-1/2" x 5-1/2"	1/8"	12', 16', 20', 24'	N/A	White, Tan & Gray

### Evernew Structural Porch Posts

	Dimension	Length	Load Bearing	Aluminum Reinforcement	Color	Includes Tie Down
Colonial	5" x 5"	108"	5000 lbs.	Yes	White & Tan	Yes
Colonial	4" x 4"	108"	2600 lbs.	Yes	White	Yes
Traditional	5" x 5"	108"	5000 lbs.	Yes	White	Yes
Square	5" x 5"	108"	5000 lbs.	Yes	White & Clay	Yes
SnapWrap	4" x 4" 6" x 6"	120"	NA	NA	White	NA



Enjoy the look and lifestyle of carefree outdoor living from CertainTeed.

**ASK ABOUT OUR OTHER CERTAINTEED PRODUCTS AND SYSTEMS:**

**EXTERIOR:** ROOFING • SIDING • WINDOWS • FENCE • DECKING • RAILING • MILLWORK • FOUNDATIONS • PIPE  
**INTERIOR:** INSULATION • WALLS • CEILINGS

CertainTeed Corporation  
P.O. Box 860  
Valley Forge, PA 19482

Professional: 800-233-8990  
Consumer: 800-782-8777  
[www.certainteed.com](http://www.certainteed.com)



**CertainTeed**